



Technical Data (R404A)

SGA...C



Nomenclature

Standard

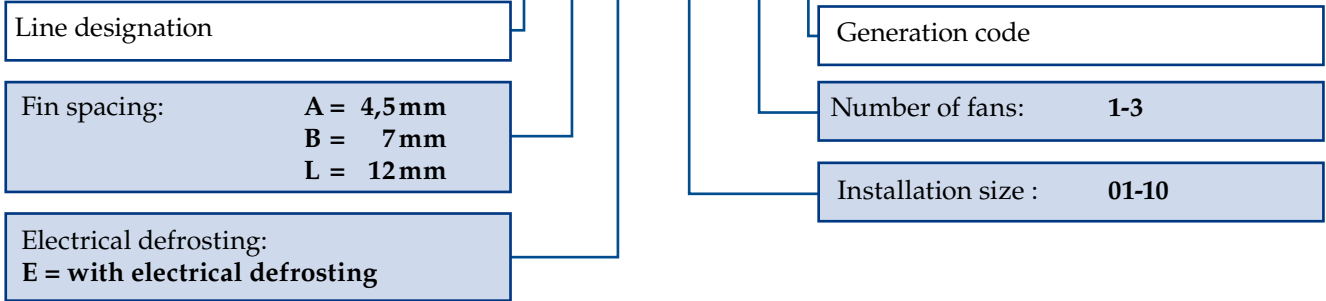

Model	Rating Q ₀ at 50 Hz		Surface m ²	Air flow m ³ /h	Air throw m	Tube volume dm ³	Connections			Fans (operating values at 50 Hz)				
	t ₁₁ ±0 °C DT1 = 8K	t ₁₁ -18 °C DT1 = 7K					Inlet Ø mm	Outlet Ø mm	Blade Ø mm	Type of current	min ⁻¹	W	A	
SGA 011C	⊕	1,00	0,79	7,3	620	7	1,3	10	15	250	230±10%	1301	32	0,15
SGA 021C	⊕	1,23	0,97	9,7	520	7	1,3	10	15	250	V-1~	1301	32	0,15
SGA 031C	⊕	1,98	1,57	12,5	1060	10	2,1	10	15	300	50/60 Hz	1295	86	0,38
SGA 041C	⊕	2,19	1,73	16,6	970	10	2,8	10	15	300	230±10%	1295	86	0,38
SGA 051C	⊕	3,45	2,74	23,1	1620	13	3,8	10	22	400	V-1~	1307	105	0,46
SGA 061C	⊕	3,81	3,03	28,7	1600	13	4,8	10	22	400	50/60 Hz	1307	105	0,46
SGA 071C	⊕	5,69	4,52	34,5	2610	19	5,7	10*	22	400		1362	205	0,90
SGA 081C	⊕	6,73	5,34	51,5	2640	19	8,8	10*	28	400		1362	205	0,90
SGA 091C	⊕	9,42	7,49	61,8	4010	23	10,6	10*	28	500	230/400	1417	360	0,86
SGA 101C	⊕	10,80	8,57	82,3	4300	23	13,6	12*	35	500	±10%V-3~	1417	360	0,86
SGA 012C	⊕⊕	1,99	1,57	14,5	1240	11	2,3	10	15	250	50/60 Hz	1301	32	0,15
SGA 022C	⊕⊕	2,45	1,94	19,2	1040	11	3,1	10	18	250		1301	32	0,15
SGA 032C	⊕⊕	3,96	3,14	24,6	2120	14	3,9	10	18	300		1295	86	0,38
SGA 042C	⊕⊕	4,38	3,47	33,0	1940	14	5,3	10	22	300	230±10%	1295	86	0,38
SGA 052C	⊕⊕	6,91	5,48	45,7	3240	18	7,6	10*	28	400	V-1~	1307	105	0,46
SGA 062C	⊕⊕	7,62	6,05	57,1	3200	18	9,1	12*	28	400	50/60 Hz	1307	105	0,46
SGA 072C	⊕⊕	10,1	9,02	68,5	5220	26	10,8	12*	35	400		1362	205	0,90
SGA 082C	⊕⊕	12,5	10,68	103,0	5280	26	16,6	15*	35	400		1362	205	0,90
SGA 092C	⊕⊕	18,86	14,98	123,0	8020	33	19,8	15*	35	500	230/400	1417	360	0,86
SGA 102C	⊕⊕	21,60	17,16	164,0	8600	33	26,1	15*	42	500	±10%V-3~	1417	360	0,86
SGA 013C	⊕⊕⊕	2,99	2,36	21,5	1860	13	3,4	10	15	250	50/60 Hz	1301	32	0,15
SGA 023C	⊕⊕⊕	3,68	2,92	28,7	1560	13	4,5	10	22	250		1301	32	0,15
SGA 033C	⊕⊕⊕	5,94	4,70	37,0	3180	17	5,8	10	28	300		1295	86	0,38
SGA 043C	⊕⊕⊕	6,57	5,20	49,2	2910	17	8,1	10*	28	300	230±10%	1295	86	0,38
SGA 053C	⊕⊕⊕	10,35	8,21	68,3	4860	22	11,1	12*	35	400	V-1~	1307	105	0,46
SGA 063C	⊕⊕⊕	11,42	9,07	85,5	4800	22	13,1	12*	35	400	50/60 Hz	1307	105	0,46
SGA 073C	⊕⊕⊕	15,2	12,1	103,0	7830	32	16,2	15*	35	400		1362	205	0,90
SGA 083C	⊕⊕⊕	18,9	14,9	154,0	7920	32	24,6	22*	42	400		1362	205	0,90
SGA 093C	⊕⊕⊕	28,29	22,47	184,0	12000	40	29,6	22*	54	500	230/400	1417	360	0,86
SGA 103C	⊕⊕⊕	32,41	25,75	246,0	12900	40	38,5	22*	54	500	±10%V-3~	1417	360	0,86

* Multiple injections with direct expansion using Küba CAL® distributors. The cooler rating at 60 Hz is 10% higher on average due to the higher speed and higher air flow.



Technical Data (R404A)

SGB...C



Model		Rating Q ₀ at 50 Hz		Surface m ²	Air flow m ³ /h	Air throw m	Tube volume dm ³	Connections			Fans (operating values at 50 Hz)			
		t ₁₁ ±0 °C DT1 = 8K	t ₁₁ -18 °C DT1 = 7K					Inlet Ø mm	Outlet Ø mm	Blade Ø mm	Type of current	min ⁻¹	W	A
		kW	kW					Ø mm	Ø mm	Ø mm				
SGB 011C	⊗	0,91	0,72	4,9	700	8	1,3	10	15	250		1301	32	0,15
SGB 021C	⊗	1,13	0,90	6,5	640	8	1,3	10	15	250		1301	32	0,15
SGB 031C	⊗	1,74	1,37	8,2	1300	12	2,1	10	15	300		1295	86	0,38
SGB 041C	⊗	2,00	1,59	11,1	1180	12	2,8	10	15	300	230±10%	1295	86	0,38
SGB 051C	⊗	2,91	2,31	15,2	1770	14	3,8	10	22	400	V-1~	1307	105	0,46
SGB 061C	⊗	3,34	2,65	19,1	1760	14	4,8	10	22	400	50/60 Hz	1307	105	0,46
SGB 071C	⊗	4,3	3,4	22,8	2460	20	5,7	10*	22	400		1362	205	0,90
SGB 081C	⊗	5,3	4,3	34,1	2770	20	8,8	10*	28	400		1362	205	0,90
SGB 091C	⊗	8,42	6,69	41,0	4530	26	10,6	10*	28	500	230/400	1417	360	0,86
SGB 101C	⊗	9,50	7,54	54,5	4660	26	13,6	12*	35	500	±10%V-3~	1417	360	0,86
SGB 102C	⊗⊗	1,82	1,44	9,5	1400	12	2,3	10	15	250	50/60 Hz	1301	32	0,15
SGB 103C	⊗⊗⊗	2,85	2,26	16,2	14000	45	38,5	22*	54	500	230/400	1417	360	0,86
SGB 122C	⊗⊗	2,27	1,79	12,7	1280	12	3,1	10	18	250		1301	32	0,15
SGB 132C	⊗⊗	3,47	2,75	16,3	2600	17	3,9	10	18	300		1295	86	0,38
SGB 142C	⊗⊗	4,00	3,17	21,7	2360	17	5,3	10	22	300	230±10%	1295	86	0,38
SGB 152C	⊗⊗	5,82	4,61	30,2	3540	19	7,6	10*	28	400	V-1~	1307	105	0,46
SGB 162C	⊗⊗	6,68	5,30	37,7	3520	19	9,1	12*	28	400	50/60 Hz	1307	105	0,46
SGB 172C	⊗⊗	8,4	6,6	45,2	4920	28	10,6	12*	35	400		1362	205	0,90
SGB 182C	⊗⊗	10,6	8,5	67,7	5540	28	16,6	15*	35	400		1362	205	0,90
SGB 192C	⊗⊗	16,86	13,37	81,2	9060	37	19,8	15*	35	500	230/400	1417	360	0,86
SGB 202C	⊗⊗	19,01	15,07	108,0	9320	37	26,1	15*	42	500	±10%V-3~	1417	360	0,86
SGB 213C	⊗⊗⊗	2,73	2,16	14,2	2100	15	3,4	10	15	250	50/60 Hz	1301	32	0,15
SGB 223C	⊗⊗⊗	3,40	2,69	19,1	1920	15	4,5	10	22	250		1301	32	0,15
SGB 233C	⊗⊗⊗	5,21	4,12	24,3	3900	21	5,8	10	28	300		1295	86	0,38
SGB 243C	⊗⊗⊗	6,00	4,76	32,5	3690	21	8,1	10*	28	300	230±10%	1295	86	0,38
SGB 253C	⊗⊗⊗	8,73	6,92	45,1	5310	24	11,1	12*	35	400	V-1~	1307	105	0,46
SGB 263C	⊗⊗⊗	10,02	7,95	56,5	5280	24	13,1	12*	35	400	50/60 Hz	1307	105	0,46
SGB 273C	⊗⊗⊗	12,6	10,1	67,6	7380	34	16,2	15*	35	400		1362	205	0,90
SGB 283C	⊗⊗⊗	16,1	12,7	101,0	8310	34	24,5	22*	42	400		1362	205	0,90
SGB 293C	⊗⊗⊗	25,29	20,07	122,0	13600	45	29,6	22*	54	500	230/400	1417	360	0,86
SGB 303C	⊗⊗⊗	28,50	22,61	162,0	14000	45	38,5	22*	54	500	±10%V-3~	1417	360	0,86

* Multiple injections with direct expansion using Küba CAL® distributors. The cooler rating at 60 Hz is 10% higher on average due to the higher speed and higher air flow.

50



Q_v Chart (EN328, R404A) SGB...C  **7 mm**

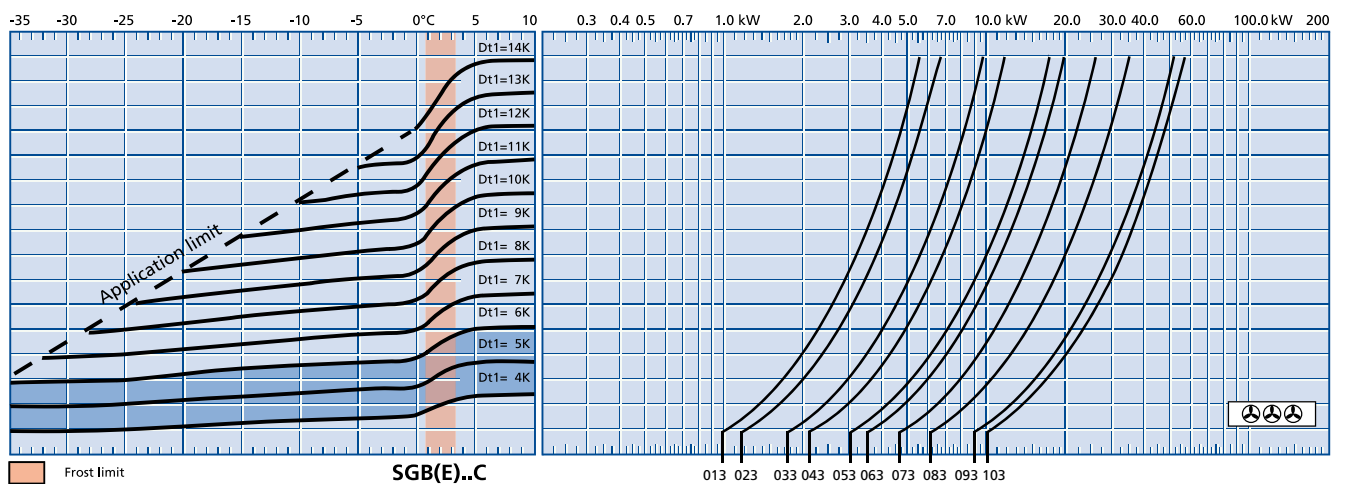
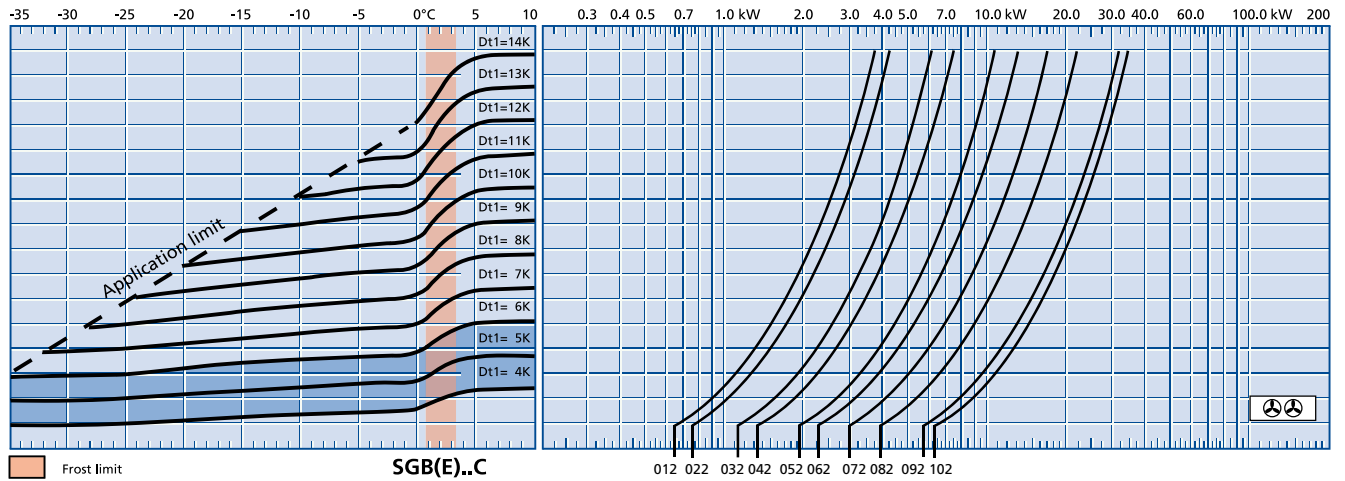
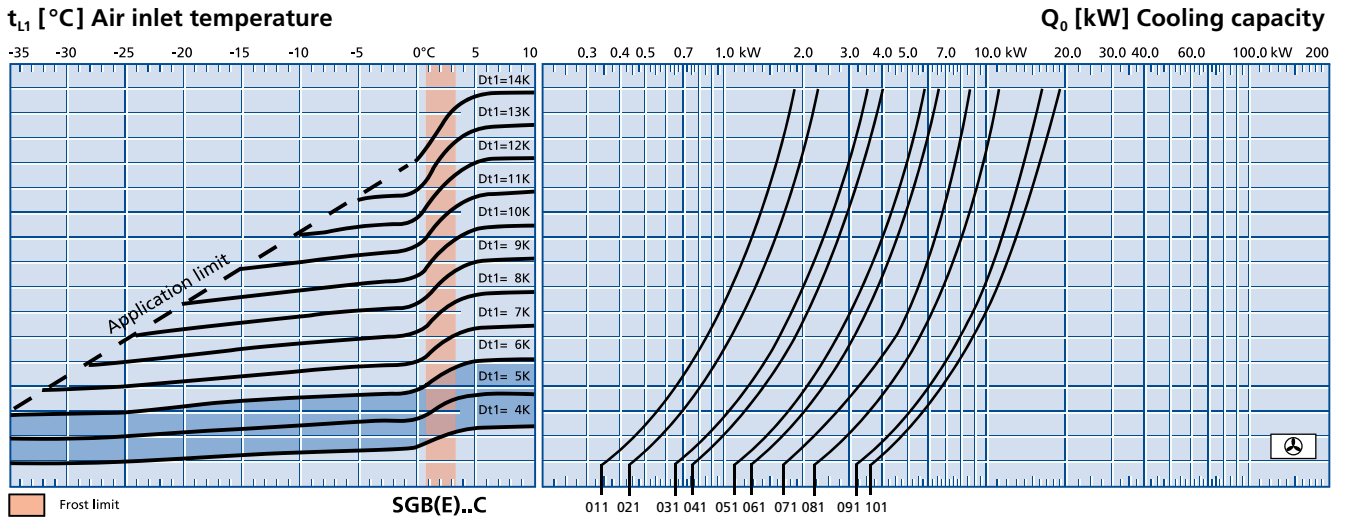

Q₀ = Cooling capacity
 t_{Li} = Air inlet temperature
 t₀ [°C] = Evaporating temperature (coil outlet)
 DT1 [K] = Temperature difference = t_{Li} - t₀ (°C)

DT1 = 4 K bis 6 K
 with electronic expansion valve

Example selection:
 For examples and explanations, please see the information section on pg. 136.



Dimensional Drawings

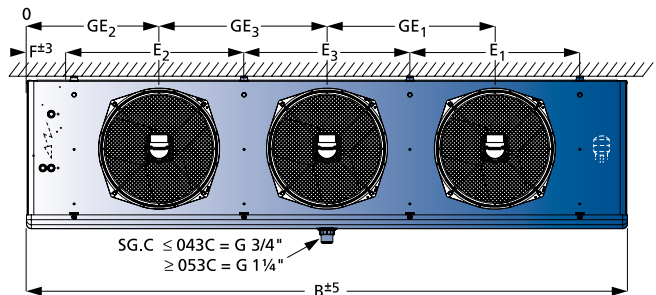
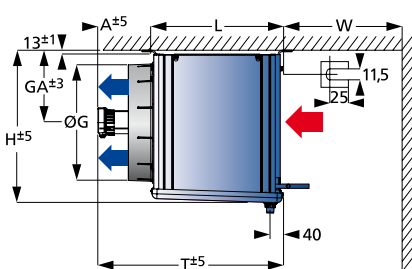
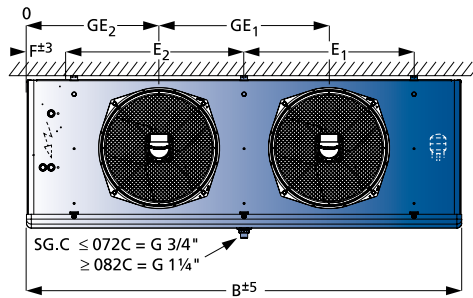
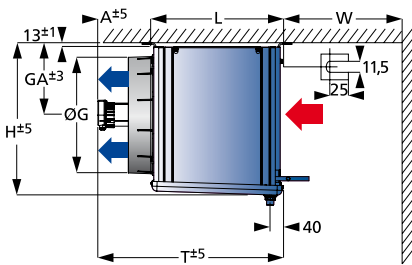
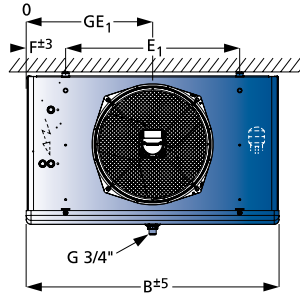
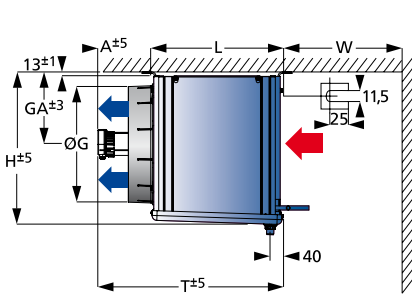

54



With double, insulated drip trays the following dimensions are changed:

- Width B: +60 mm
- Height H: +30 mm
- Depth T: +30 mm

Sound power level L_{WA} [dB(A)]



Größe	SGA/SGB/SGL		
	⊕	⊕ ⊕	⊕ ⊕ ⊕
01	59	62	64
02	59	62	64
03	66	69	71
04	66	69	71
05	70	73	75
06	70	73	75
07	75	78	80
08	75	78	80
09	78	81	83
10	78	81	83



Dimensional Drawings, Electric Defrosting, Weights

Size	Dimensions [mm]																Electrical Defrosting			Net weight		
	H	B	T	L	E ₁	E ₂	E ₃	F	A	W	W Hood	ØG	GA	GE ₁	GE ₂	GE ₃	Coil	Tray	Total	SGA	SGB	SGL
	mm	mm	mm	mm	mm	mm	mm	mm	mm	mm	mm	mm	mm	mm	mm	mm	mm	kW	kW	kW	kg	kg
011C	360	565	420	345	380	-	-	93	80	200	290	265	160	283	-	-	0,77	0,35	1,16	12	11	-
021C	360	565	420	345	380	-	-	93	80	200	290	265	160	283	-	-	0,77	0,35	1,16	13	12	-
031C	460	665	440	345	480	-	-	93	100	200	340	321	210	333	-	-	0,96	0,42	1,38	18	17	-
041C	460	665	440	345	480	-	-	93	100	200	340	321	210	333	-	-	0,96	0,42	1,38	20	19	-
051C	560	815	570	415	530	-	-	143	160	300	430	419	260	408	-	-	1,44	0,24	1,68	30	29	28
061C	560	815	570	415	530	-	-	143	160	300	430	419	260	408	-	-	1,61	0,24	1,85	33	32	30
071C	560	915	640	495	630	-	-	143	150	300	430	419	260	458	-	-	1,73	0,29	2,02	41	39	37
081C	560	1065	640	495	780	-	-	143	150	300	430	419	260	533	-	-	2,18	0,35	2,53	53	51	49
091C	660	1065	650	495	780	-	-	143	160	400	500	525	320	533	-	-	2,90	0,35	3,25	62	59	56
101C	660	1315	650	495	1030	-	-	143	160	400	500	525	320	658	-	-	3,68	0,44	4,12	71	68	65
012C	360	1015	420	345	730	365	-	143	80	200	290	265	160	690	325	-	1,38	0,69	2,07	23	21	19
022C	360	1015	420	345	730	365	-	143	80	200	290	265	160	690	325	-	1,38	0,69	2,07	24	22	20
032C	460	1215	440	345	930	465	-	143	100	200	340	321	210	840	375	-	1,72	0,77	2,49	35	33	31
042C	460	1215	440	345	930	465	-	143	100	200	340	321	210	840	375	-	1,72	0,77	2,49	39	37	35
052C	560	1375	570	415	1030	515	-	173	160	300	430	419	260	945	430	-	2,64	0,44	3,08	58	55	53
062C	560	1375	570	415	1030	515	-	173	160	300	430	419	260	945	430	-	2,64	0,44	3,08	64	61	58
072C	560	1575	640	495	1230	615	-	173	150	300	430	419	260	1095	480	-	3,11	0,52	3,63	80	76	72
082C	560	1875	640	495	1530	765	-	173	150	300	430	419	260	1320	555	-	3,90	0,65	4,55	104	100	96
092C	660	1875	650	495	1530	765	-	173	160	400	500	525	320	1320	555	-	6,50	0,65	7,15	120	114	108
102C	660	2375	650	495	2030	1015	-	173	160	400	500	525	320	1695	680	-	8,42	0,84	9,27	137	130	123
013C	360	1365	420	345	1080	365	715	143	80	200	290	265	160	1040	325	683	1,84	0,92	2,76	34	31	28
023C	360	1365	420	345	1080	365	715	143	80	200	290	265	160	1040	325	683	1,84	0,92	2,76	37	34	31
033C	460	1665	440	345	1380	465	915	143	100	200	340	321	210	1290	375	833	2,42	1,21	3,63	51	48	45
043C	460	1665	440	345	1380	465	915	143	100	200	340	321	210	1290	375	833	2,42	1,21	3,63	57	54	51
053C	560	1875	570	415	1530	515	1015	173	160	300	430	419	260	1445	430	938	3,90	0,65	4,55	86	81	76
063C	560	1875	570	415	1530	515	1015	173	160	300	430	419	260	1445	430	938	3,90	0,65	4,55	95	90	85
073C	560	2175	640	495	1830	615	1215	173	150	300	430	419	260	1695	480	1088	4,47	0,75	5,22	118	111	104
083C	560	2625	640	495	2280	765	1515	173	150	300	430	419	260	2070	555	1313	5,63	0,94	6,57	154	147	140
093C	660	2625	650	495	2280	765	1515	173	160	400	500	525	320	2070	555	1313	9,37	0,94	10,32	180	170	160
103C	660	3375	650	495	3030	1015	2015	173	160	400	500	525	320	2695	680	1688	12,09	1,82	13,92	240	228	216



The dimensions are only valid for the standard model design!
 Note the differences in dimension among versions and accessories.



Models

Motor versions

- **Version V1.33 – quiet design**
Especially suited for sales areas, etc.
- Reduced air flow rate, VL
- Lower sound power level, Lw (A)
- Fans 230 ± 10% V-1~



For alternative motor versions, see Küba Select or version overview, p. 126

Water/brine circulation

- **Version V2.05**
Large number of circuits (small pressure drop)
- **Version V2.06**
Small number of circuits (large pressure drop)

Casing versions

Double insulated drip tray

- **V3.09**



The double insulated drip tray has 25 mm of insulation.

The insulation prevents condensation water from building up on the bottom side of the tray and reduces the transfer of defrosting heat into the Cold Room.

This changes the following dimensions:

- Width B:** +60 mm
- Hight H:** +30 mm
- Depth T:** +30 mm

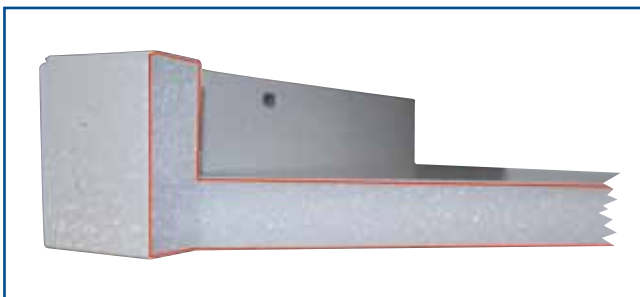

Hinged fans

- **V3.10**

To make the coolers easy to clean, the fans are mounted with stainless steel hinges.



Hinge-down drip tray

- **V3.11**

The hinge-down drip tray is easy to assemble and makes it easy to clean the devices from below.



Defrost versions

All GEA Küba Air Coolers are available with electric defrosting. See nomenclature, p. 48

Hot gas defrost in the drip tray

- Hot gas connection on both sides
- V4.01 Copper design
- V4.02 Stainless steel design



Hot gas in the heat exchanger

- V6.05 Hot gas connection on the heat exchanger



**Hot gas in the heat exchanger and in the drip tray, copper design
Copper with/without check valve**

- Hot gas connection on both sides
- V6.07 with check valve
- V6.08 without check valve

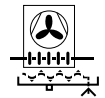
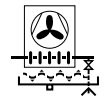

Upon request: additional defrosting circuit: warm brine; the circuit is integrated into the heat exchanger.

Corrosion protection

Stainless steel casing

- **V3.12**



For protection in aggressive cold storage air, i.e. in smokehouses and curing areas, all casing components are stainless steel and of industrial quality.

- **Version V6.01**

Heat exchanger:

- Tubing: Cu
- Fins: Al „goldlack“ coating
- End plates: Al protective coating on both sides



Casing:

Al-Stucco, protective coating on both sides



Accessories

Adapter for textile hose connection and Shut-Up®

With the Küba Shut-Up® and fitting adapter, (aluminium, powder-coated RAL 9018) mounting a PVC or textile hose is quick and easy.

Air Guiding Grid design: plastic (not suitable for fan collar heaters)

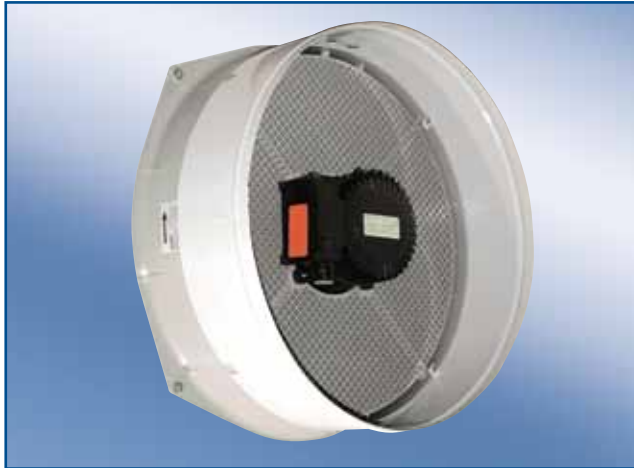

Selection table

For Air Coolers	Adapter		Note
	Quantity	ØG mm	
SG 011-021C	1	270	
SG 031-041C	1	325	
SG 051-061C	1	425	
SG 071-081C	1	425	
SG 091-101C	1	525	
SG 012-022C	2	270	
SG 032-042C	2	325	Not assembled upon delivery (cannot be used with electric defrosting SGHR)
SG 052-062C	2	425	
SG 072-082C	2	425	
SG 092-102C	2	525	
SG 013-023C	3	270	
SG 033-043C	3	325	
SG 053-063C	3	425	
SG 073-083C	3	425	
SG 093-103C	3	525	



For greater pressure drops we recommend using more powerful fans. When using textile or PVC hoses, take the Ø G (mm) in the selection table into consideration. For more information, contact our sales engineers, Tel.: ++49 (0)89 / 74473-0. For more detailed information, please see the information provided by the textile or PVC hose manufacturer.

Fan unit for assembling fan collar heaters

This fan unit (collar made of aluminium, powder-coated RAL 9018) is used to assemble a fan collar heater.

Fan unit design: suitable for use with fan collar heaters

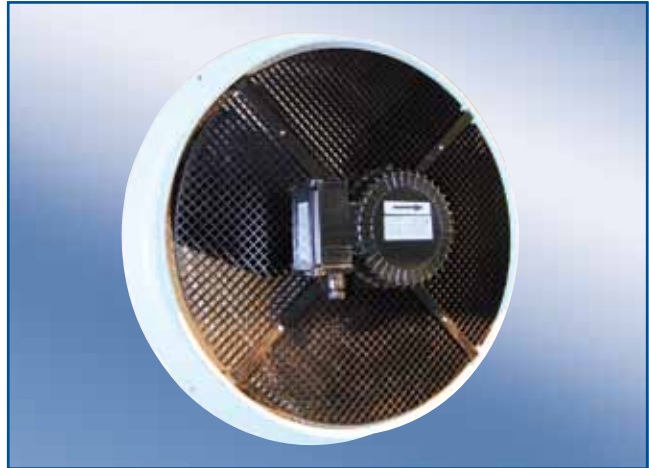

Applications

- Assembling fan collar heaters for deep-freezing starting at -18 °C

If fan collar heaters are used for a deep-freeze application, a fan with an aluminium collar must be used instead of the standard fan unit. Please note this in planning.

Scope of delivery

Complete fan unit consisting of:

- | | |
|-------------------|--|
| Collar: | Al Stucco,
white powder-coated RAL 9018
Food safe
High protection against corrosion |
| Air Guiding Grid: | Plastic |
| Motor and blade: | Standard |



Accessories

Mounting material, wall bracket / floor bracket

Wall bracket (WK)

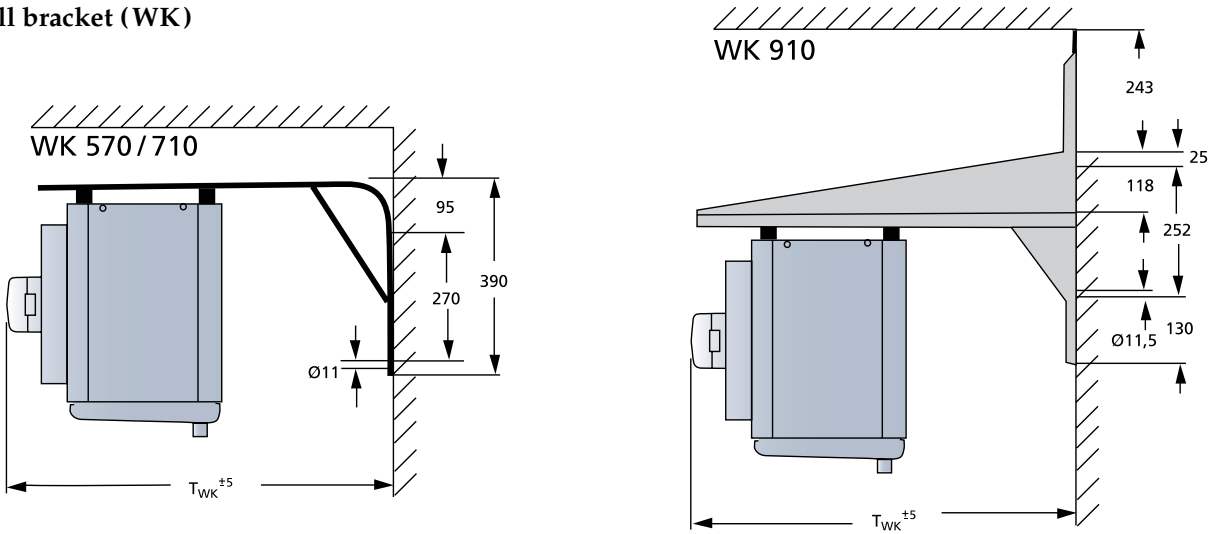

Design: Galvanised steel

SG.	011-013C	021-023C	031-033C	041-043C	051-053C	061-063C	071-073C	081-083C	091-093C	101-103C
WK	570	570	570	570	710	710	910	910	910	910
T _{WK} [mm]	615	615	635	635	835	835	1000	1000	1010	1010

Floor brackets (SK)

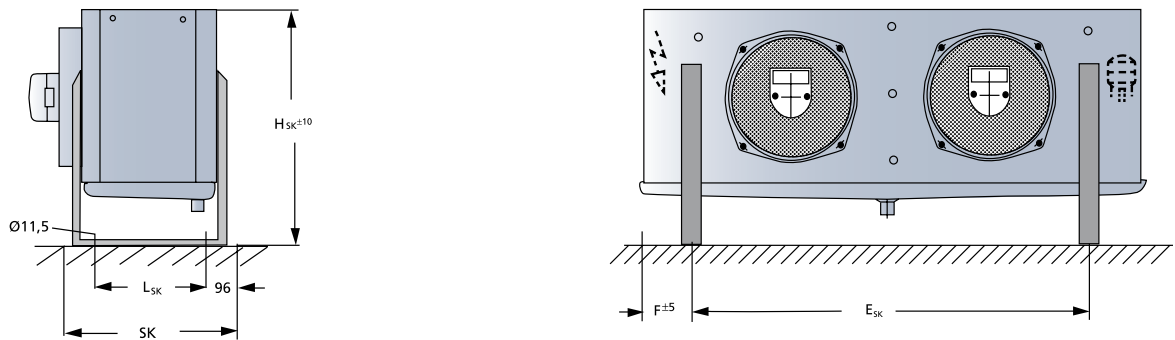

Design: SK 460, 510 = Al

SG.		051-053C	061-063C	071-073C	081-083C	091-093C	101-103C
SK		460	460	460	460	510	510
Dimensions [mm]	SK	460	460	460	460	510	510
	H _{SK}	685	685	785	785	785	785
	L _{SK}	478	478	558	558	558	558
	E _{SK}	} ≙ E1 und F } ≙ According to dimension table p.55					
	F						

No floor mounting brackets are available for SG. 011 - 043C.



Construction

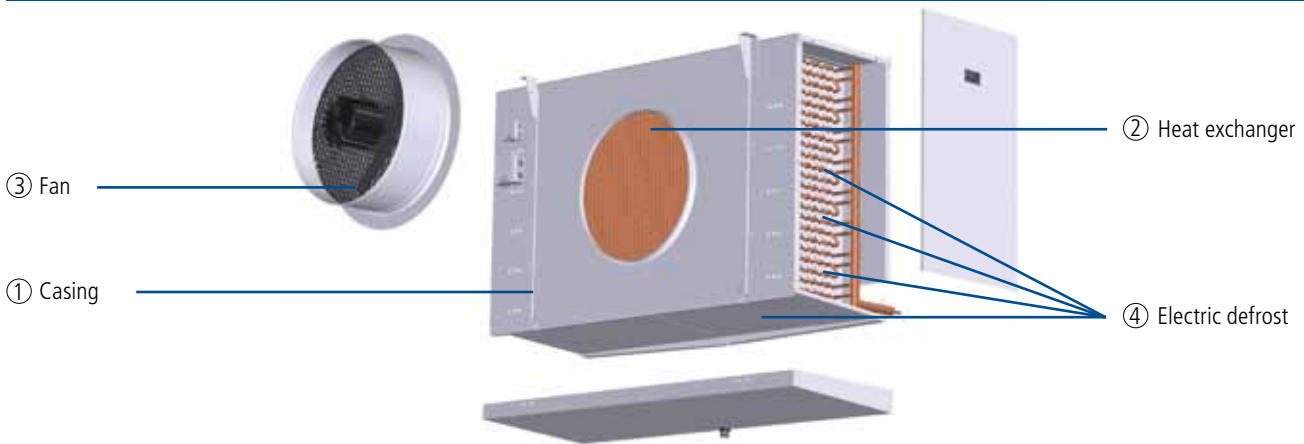

1. Casing

- Smooth Sendzimir galvanised steel
- High-grade powder coating, papyrus white RAL 9018
 - Food safe
 - Easy to clean
 - Optimum corrosion protection
- Hinge-down drip tray and removable side panels
- Stainless steel mounting material
- Plastic drain up to 1 1/4", longer than 2", stainless steel

2. Heat exchanger

- Fin spacing
 - SGA.I: 4,5 mm
 - SGB.I: 7 mm
 - SGK.I: 12 mm
- Aligned tube arrangement, spacing 50 x 50 mm
- HFE® tube / fin system
- **SG industrial-F: HFC/CO₂**
Küba-CAL® refrigerant distributor from the entire HFC/CO₂ line (up to 32 bar)
 - Tubing: Cu-special
 - Fins: Al
 - End plates: Al
- **SG industrial-G: Glycol**
Distributor tubes for multiple injections
 - Tubing: Cu-special
 - Fins: Al
 - End plates: Al
- **SG industrial-N: Pump operation, NH₃**
Distributor tubes for multiple injections
 - Tubing: VA
 - Fins: Al
 - End plates: Al

3. Fans

- Ø 500 / 560 / 630 / 710 / 800 mm
- With built-in protector to be connected on site

- Application range: -40 °C to +45 °C
- 400 ± 10% V-3~ 50Hz
- In the standard design the fans are equipped with Air Guiding Grid, air duct and contact protection.
- Protection class IP 66
- Insulation class F
- Operating data can be found with Küba Select or in the technical data.
- Optional Controller:
 - Phase control
 - Transformer
 - Delta / star
 - Frequency converter with all-pole sinusoidal filter

⚠ Please observe the manufacturer's information.

Motor label data (max. allowable value +40 °C)
50 Hz

	min ⁻¹	W	A
SG. 50-F41-F85	1400	800	1,40
SG. 56-F41-F85	1350	1400	2,50
SG. 63-F41-F85	880	680	1,60
SG. 71-F41-F84	900	1200	2,30
SG. 80-F41-F84	930	2200	3,50

4. Electric defrost

- 230 ± 10% V-1~ or 400 ± 10% V-3~ -Y
- Heaters with CrNi steel sleeve
- Vapour-tight connections
- Connector cable 1,5 mm² x 1000 mm
- Designed to defrost the heat exchanger quickly and evenly
- To prevent vapor build-up and to promote heat exchange with little loss, the heaters are mounted in special expanded tube sleeves
- Wired ready for connection to the connection box in accordance with VDE specifications



Q_v Chart (EN 328, R404A)

SGB-F



t_{l1} [°C] Air inlet temperature

Q₀ [kW] Cooling capacity

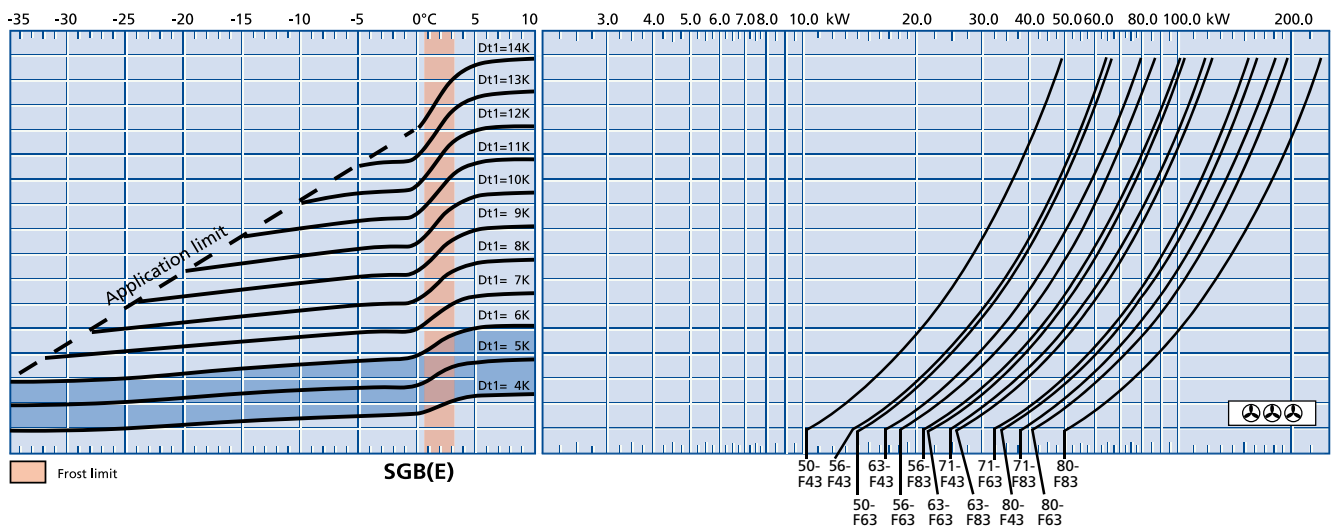
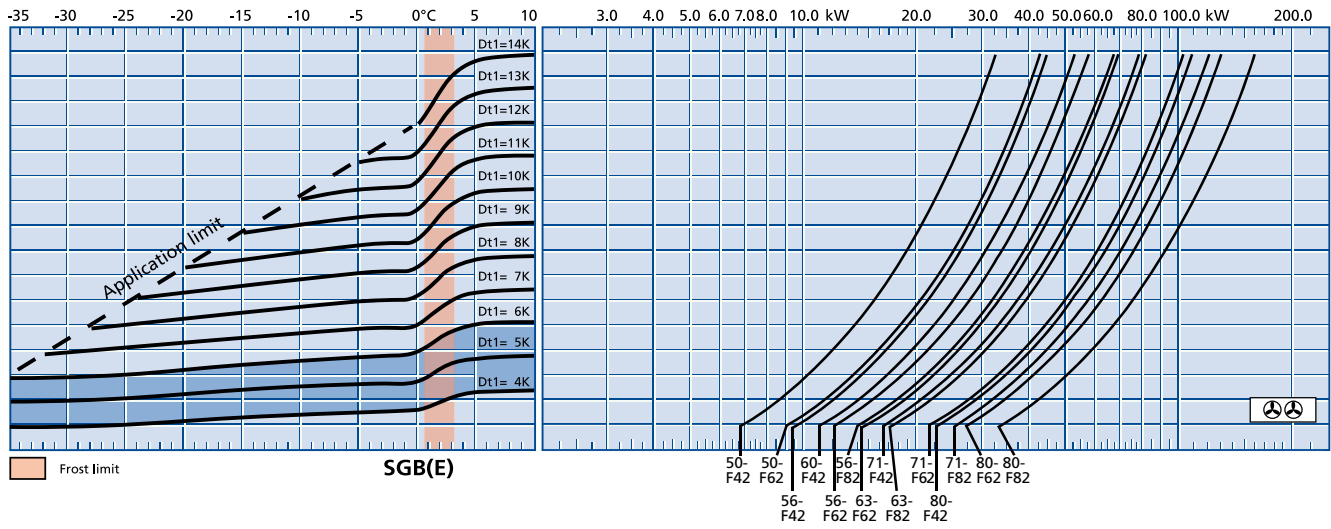
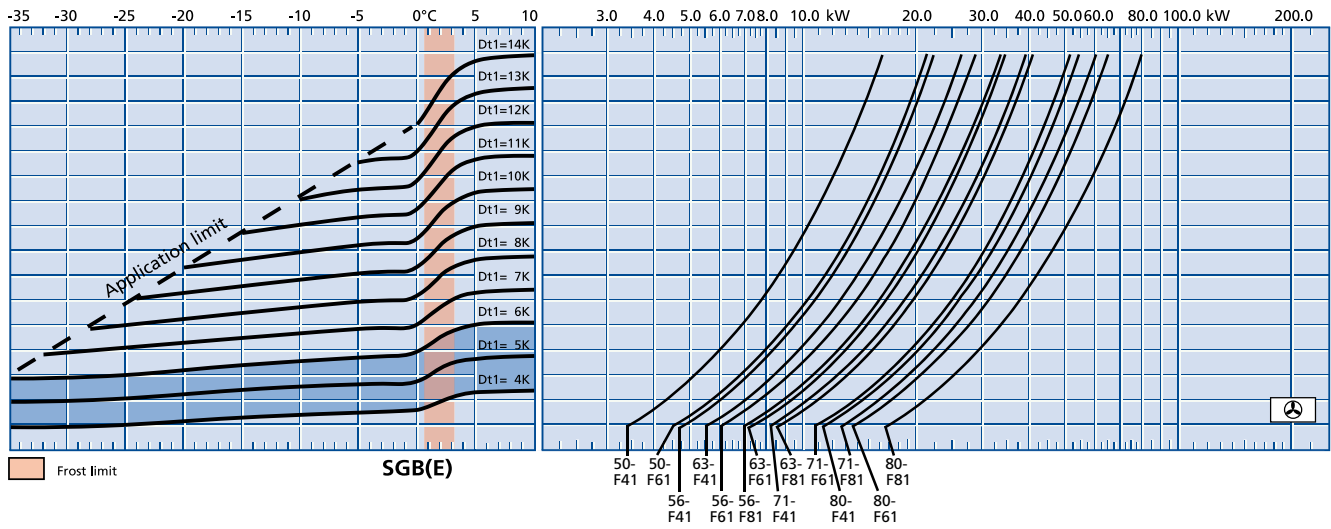

78



Q_v Chart (EN 328, R404A) SGB-F 7 mm

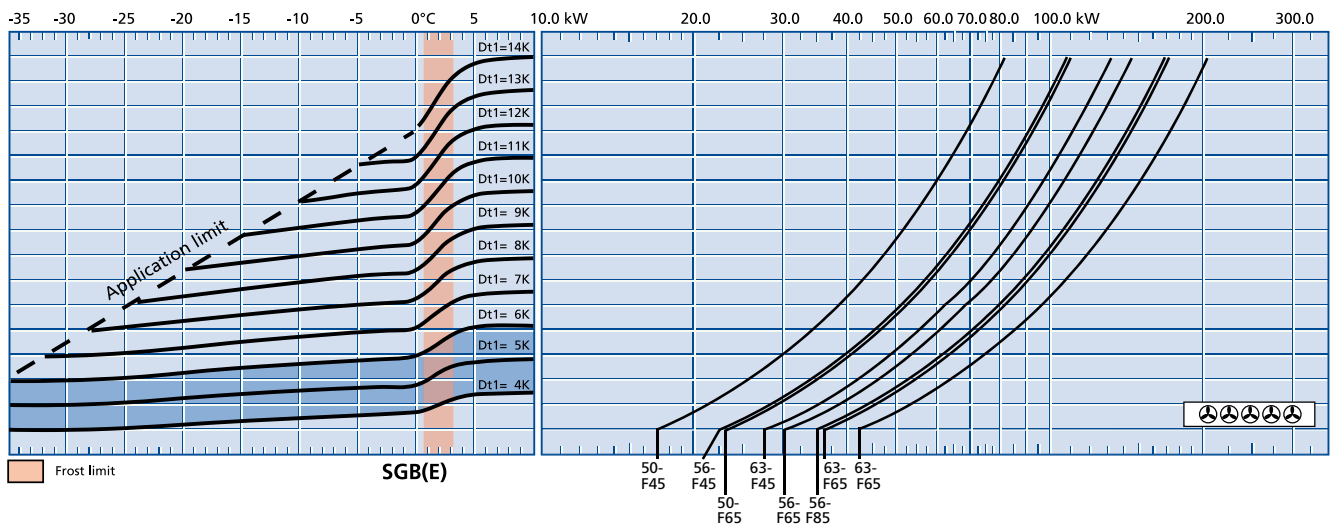
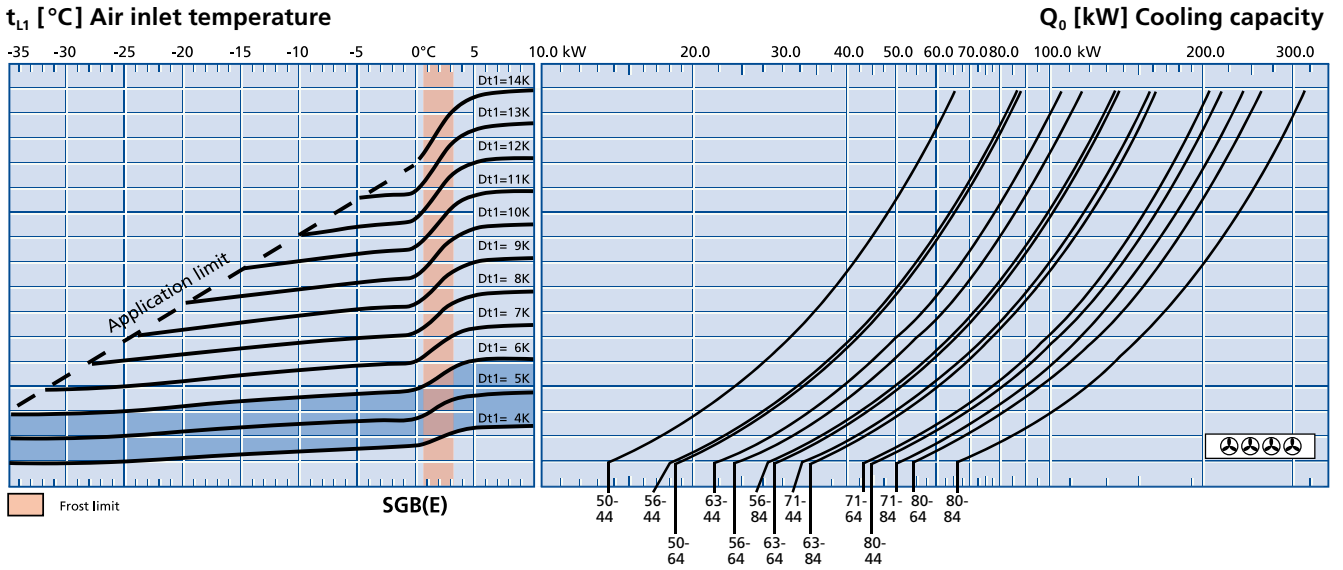

Q₀ = Cooling capacity
 t_{L1} = Air inlet temperature
 t₀ [°C] = Evaporating temperature (coil outlet)
 DT1 [K] = Temperature difference = t_{L1} - t₀ (°C)

**DT1 = 4 K bis 6 K
 with electronic expansion valve**

Example selection:
 For examples and explanations, please see the information section on pg. 136.



Dimensional Drawings, Electric Defrost, Weights

Size	Dimensions [mm]																Electrical defrost			Net weight						
	H	B	T	L	E ₁	E ₂	E ₃	E ₄	E ₅	A	W	W _{min}	ØG	GA	GE ₁	GE ₂	GE ₃	GE ₄	GE ₅	Coil	Tray	Total	SGA	SGB	SGK	SGL
	mm	mm	mm	mm	mm	mm	mm	mm	mm	mm	mm	mm	mm	mm	mm	mm	mm	mm	mm	kW	kW	kW / *	kg	kg	kg	kg
50-41	720	1620	870	704	1054	-	-	-	-	190	500	860	518	329	783	-	-	-	-	4,78	2,29	7,07/1	130	122	119	117
50-61	720	1620	870	704	1054	-	-	-	-	190	500	860	518	329	783	-	-	-	-	5,97	2,29	8,26/1	146	139	130	127
56-41	920	1620	870	704	1054	-	-	-	-	190	550	860	576	429	783	-	-	-	-	6,69	2,29	8,98/1	163	152	149	146
56-61	920	1620	870	704	1054	-	-	-	-	190	550	860	576	429	783	-	-	-	-	7,96	2,29	10,25/2	185	164	165	163
56-81	920	1620	870	704	1054	-	-	-	-	190	550	860	576	429	783	-	-	-	-	10,51	2,29	12,8/2	214	192	184	180
63-41	1020	1820	895	729	1254	-	-	-	-	190	600	960	639	479	883	-	-	-	-	9,16	2,60	11,76/2	205	192	186	182
63-61	1020	1820	895	729	1254	-	-	-	-	190	600	960	639	479	883	-	-	-	-	10,31	2,60	12,91/2	236	215	208	203
63-81	1020	1820	895	729	1254	-	-	-	-	190	600	960	639	479	883	-	-	-	-	13,74	2,60	16,34/2	269	241	232	225
71-41	1325	2020	1040	757	1454	-	-	-	-	310	700	1340	734	629	983	-	-	-	-	14,30	2,87	17,17/2	286	264	257	251
71-61	1325	2020	1040	757	1454	-	-	-	-	310	700	1340	734	629	983	-	-	-	-	15,60	2,87	18,47/2	334	301	290	281
71-81	1325	2020	1040	757	1454	-	-	-	-	310	700	1340	734	629	983	-	-	-	-	22,10	2,87	24,97/2	387	343	328	317
80-41	1535	2020	1130	757	1454	-	-	-	-	400	800	1340	804	729	983	-	-	-	-	16,90	2,87	19,77/2	352	309	301	295
80-61	1535	2020	1130	757	1454	-	-	-	-	400	800	1340	804	729	983	-	-	-	-	18,20	2,87	21,07/2	401	353	341	331
80-81	1535	2020	1130	757	1454	-	-	-	-	400	800	1340	804	729	983	-	-	-	-	26,00	2,87	28,87/2	452	400	384	370
50-42	720	2620	870	704	2054	1000	-	-	-	190	500	860	518	329	1783	783	-	-	-	8,60	3,75	12,35/2	214	199	193	189
50-62	720	2620	870	704	2054	1000	-	-	-	190	500	860	518	329	1783	783	-	-	-	10,80	3,75	14,55/2	247	223	216	210
56-42	920	2620	870	704	2054	1000	-	-	-	190	550	860	576	429	1783	783	-	-	-	12,04	3,75	15,79/2	268	247	241	235
56-62	920	2620	870	704	2054	1000	-	-	-	190	550	860	576	429	1783	783	-	-	-	14,40	3,75	18,15/2	313	282	271	268
56-82	920	2620	870	704	2054	1000	-	-	-	190	550	860	576	429	1783	783	-	-	-	18,92	3,75	22,67/2	363	321	307	296
63-42	1020	3020	895	729	2454	1200	-	-	-	190	600	960	639	479	2083	883	-	-	-	16,00	4,33	20,33/2	347	319	310	302
63-62	1020	3020	895	729	2454	1200	-	-	-	190	600	960	639	479	2083	883	-	-	-	18,00	4,33	22,33/2	410	367	353	342
63-82	1020	3020	895	729	2454	1200	-	-	-	190	600	960	639	479	2083	883	-	-	-	24,00	4,33	28,33/2	473	416	398	384
71-42	1325	3420	1040	757	2854	1400	-	-	-	310	700	1340	734	629	2383	983	-	-	-	24,75	4,84	29,59/2	486	441	427	416
71-62	1325	3420	1040	757	2854	1400	-	-	-	310	700	1340	734	629	2383	983	-	-	-	27,00	4,84	31,84/2	584	516	494	478
71-82	1325	3420	1040	757	2854	1400	-	-	-	310	700	1340	734	629	2383	983	-	-	-	38,25	4,84	43,09/3	680	592	562	540
80-42	1535	3420	1130	757	2854	1400	-	-	-	400	800	1340	804	729	2383	983	-	-	-	29,25	4,84	34,09/2	610	523	508	495
80-62	1535	3420	1130	757	2854	1400	-	-	-	400	800	1340	804	729	2383	983	-	-	-	31,50	4,84	36,34/2	687	608	584	565
80-82	1535	3420	1130	757	2854	1400	-	-	-	400	800	1340	804	729	2383	983	-	-	-	45,00	4,84	49,84/3	802	696	664	638
50-43	720	3620	870	704	3054	1000	2000	-	-	190	500	860	518	329	2783	783	1783	-	-	13,00	5,20	18,2/2	302	278	270	264
50-63	720	3620	870	704	3054	1000	2000	-	-	190	500	860	518	329	2783	783	1783	-	-	15,60	5,20	20,8/2	353	317	306	297
56-43	920	3620	870	704	3054	1000	2000	-	-	190	550	860	576	429	2783	783	1783	-	-	18,20	5,20	23,4/2	377	345	335	327
56-63	920	3620	870	704	3054	1000	2000	-	-	190	550	860	576	429	2783	783	1783	-	-	20,80	5,20	26/2	446	399	383	379
56-83	920	3620	870	704	3054	1000	2000	-	-	190	550	860	576	429	2783	783	1783	-	-	28,60	5,20	33,8/3	519	454	433	417
63-43	1020	4220	895	729	3654	1200	2400	-	-	190	600	960	639	479	3283	883	2083	-	-	23,84	5,96	29,8/2	490	447	490	422
63-63	1020	4220	895	729	3654	1200	2400	-	-	190	600	960	639	479	3283	883	2083	-	-	26,82	5,96	32,78/2	583	517	583	481
63-83	1020	4220	895	729	3654	1200	2400	-	-	190	600	960	639	479	3283	883	2083	-	-	35,76	5,96	41,72/3	679	594	680	544
71-43	1325	4820	1040	757	4254	1400	2800	-	-	310	700	1340	734	629	3783	983	2383	-	-	37,84	6,88	44,27/3	704	637	701	599
71-63	1325	4820	1040	757	4254	1400	2800	-	-	310	700	1340	734	629	3783	983	2383	-	-	41,28	6,88	47,64/3	847	746	710	688
71-83	1325	4820	1040	757	4254	1400	2800	-	-	310	700	1340	734	629	3783	983	2383	-	-	58,48	6,88	64,49/4	999	866	997	790
80-43	1535	4820	1130	757	4254	1400	2800	-	-	400	800	1340	804	729	3783	983	2383	-	-	44,72	6,88	51,01/3	886	755	732	712
80-63	1535	4820	1130	757	4254	1400	2800	-	-	400	800	1340	804	729	3783	983	2383	-	-	48,16	6,88	54,38/3	999	880	844	815
80-83	1535	4820	1130	757	4254	1400	2800	-	-	400	800	1340	804	729	3783	983	2383	-	-	68,80	6,88	74,6/4	1179	1021	973	933
50-44	720	4620	870	704	4054	1000	2000	3000	-	190	500	860	518	329	3783	783	1783	2783	-	16,85	6,74	22,64/2	375	343	333	325
50-64	720	4620	870	704	4054	1000	2000	3000	-	190	500	860	518	329	3783	783	1783	2783	-	20,22	6,74	25,82/2	441	393	378	366
56-44	920	4620	870	704	4054	1000	2000	3000	-	190	550	860	576	429	3783	783	1783	2783	-	23,59	6,74	29/2	470	428	414	404
56-64	920	4620	870	704	4054	1000	2000	3000	-	190	550	860	576	429	3783	783	1783	2783	-	26,96	6,74	32,18/2	560	497	476	470
56-84	920	4620	870	704	4054	1000	2000	3000	-	190	550	860	576	429	3783	783	1783	2783	-	37,07	6,74	41,72/3	648	564	536	515
63-44	1020	5420	895	729	4854	1200	2400	3600	-	190	600	960	639	479	4483	883	2083	3283	-	31,20	7,80	39/3	633	576	558	543
63-64	1020	5420	895	729	4854	1200	2400	3600	-	190	600	960	639	479	4483	883	2083	3283	-	35,10	7,80	42,9/3	755	670	642	621
63-84	1020	5420	895	729	4854	1200	2400	3600	-	190	600	960	639	479	4483	883	2083	3283	-	46,80	7,80	54,6/4	883	768	731	703
71-44	1325	6220	1040	757	5654	1400	2800	4200	-	310	700	1340	734	629	5183	983	2383	3783	-	47,92	8,71	57,2/3	895	806	777	755
71-64	1325	6220	1040	757	5654	1400	2800	4200	-	310	700	1340	734	629	5183	983	2383	3783	-	52,27	8,71	61,6/4	1084	949	905	872
71-84	1325	6220	1040	757	5654	1400	2800	4200	-	310	700	1340	734	629	5183	983	2383	3783	-	74,05	8,71	83,6/4	1280	1101	1043	999
80-44	15																									